

# 33-0010-R5

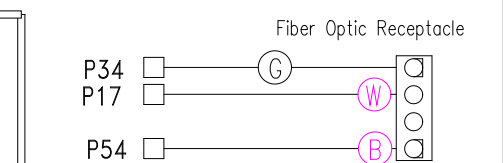
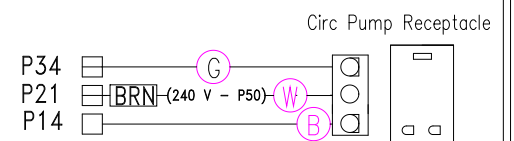
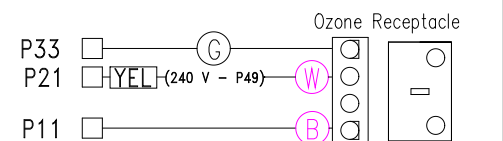
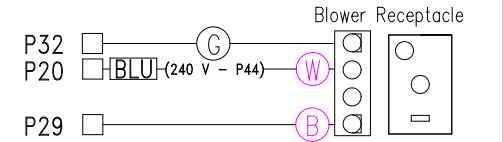
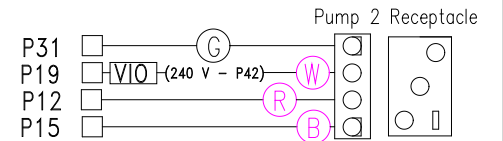
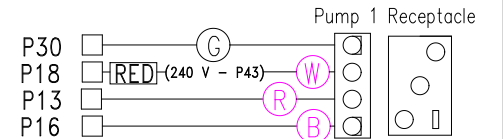
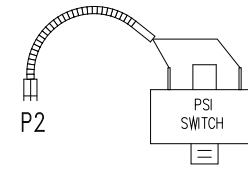
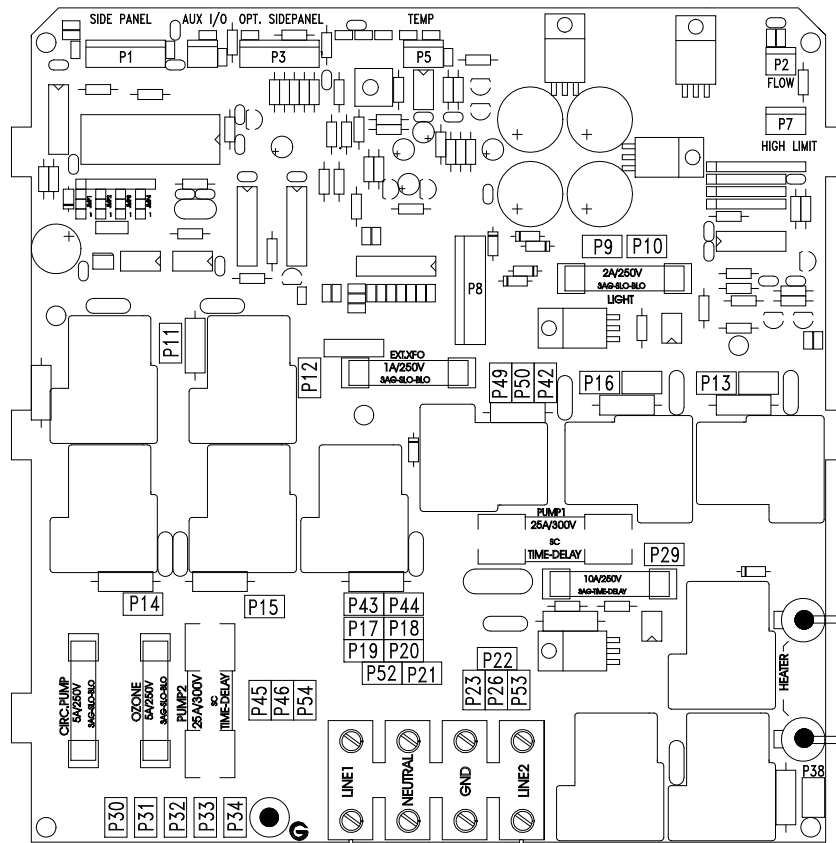
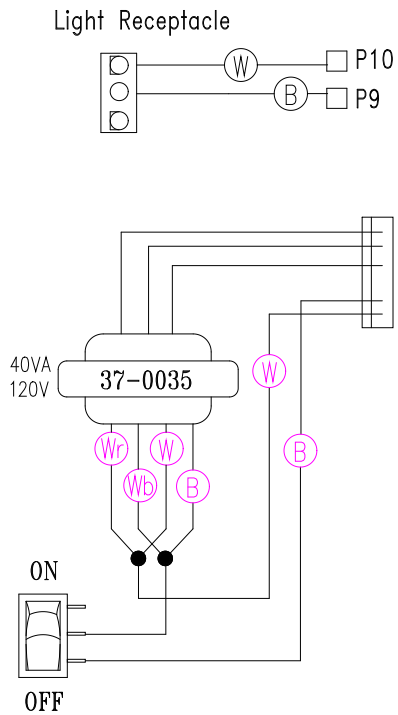

LEGEND	
	- 1/4" QUICK CONNECT
	- 1/4" QUICK CONNECT PIGGYBACK
	- FORK CONNECTOR
	- RING CONNECTOR
	- SOCKET CONNECTOR
	- PIN CONNECTOR

**HYDRO-QUIP**  
CORONA, CA (909) 273-7575

Manufacture Notes:

- #1 For 240V operation of the heater, plug must be installed into 240V receptacle.  
For 120V operation of the heater, plug must be installed into 120V receptacle.
- #2 Line 1 and 2 need to be SEPARATED for 240V operation.  
Line 1 and 2 need to be CONNECTED for 120V operation.

Approved By:

Dwg. No.  
**CR21A0-AKMPQY8-C**

Drawn  
TDM

Date  
6.5.01

Diagram No.  
4506

Rev  
6

Wire Color Code

B - Black	G - Green
Br - Brown	Bl - Blue
R - Red	V - Violet
O - Orange	W - White
Y - Yellow	Gr - Gray

